

RETURN HOME (KAERO)

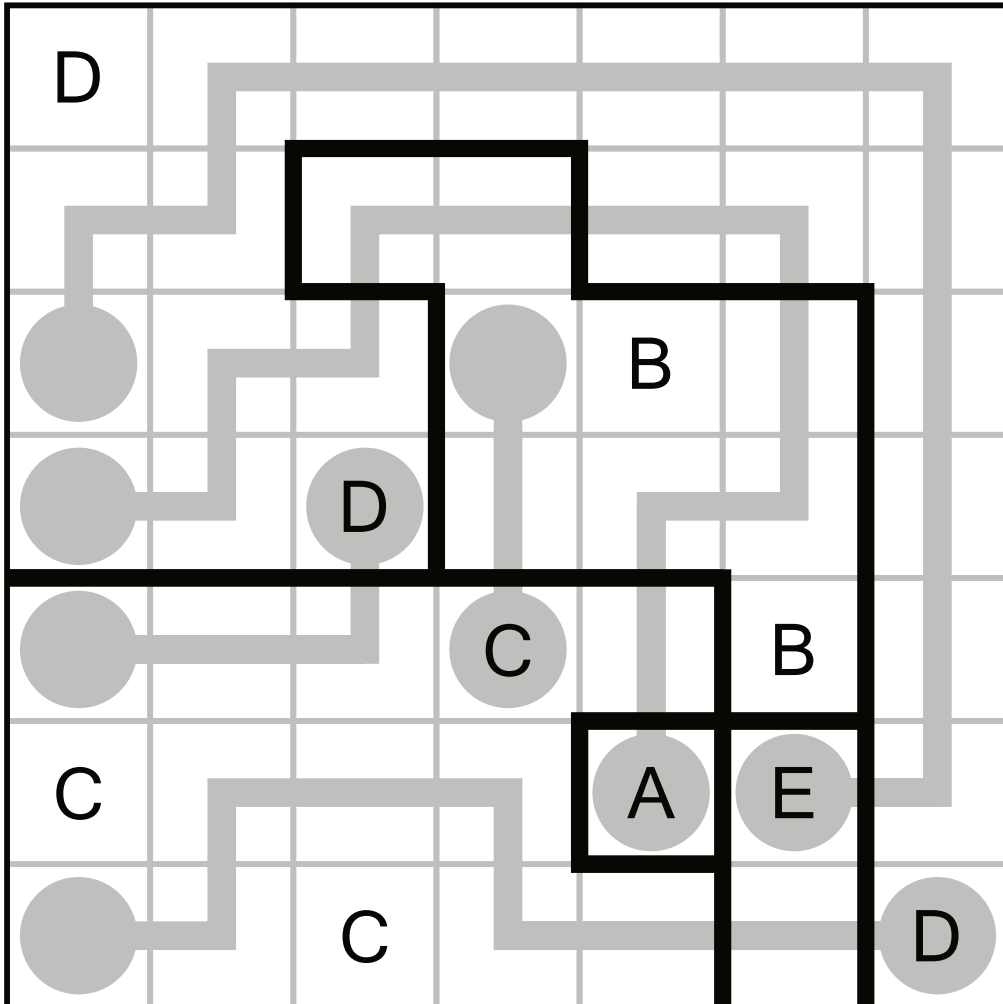

KAER-2-007S; © SortedPuzzles