

Letter Square Zine / Week 38

Use all the letters in the square at least once, in as few words as possible (max. 5 words). Start at any letter, and then select the second letter from a different side of the square. In this manner, form words that are at least 3-letters long.

The first letter of each new word must be the last letter of the previous word. Consecutive use of letters from the same side is not allowed. Aim for a two-word sequence.

Example:

The word sequence AMUSED-DOLPHIN uses up all the letters. Each letter is chosen from a different side every time.

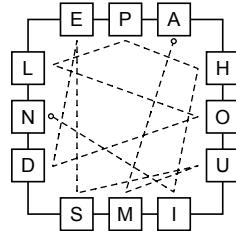

Letter Square Zine 2025-W38 / © SortedPuzzles

Letter Square Zine 2025-W38 / © SortedPuzzles

Puzzle 7

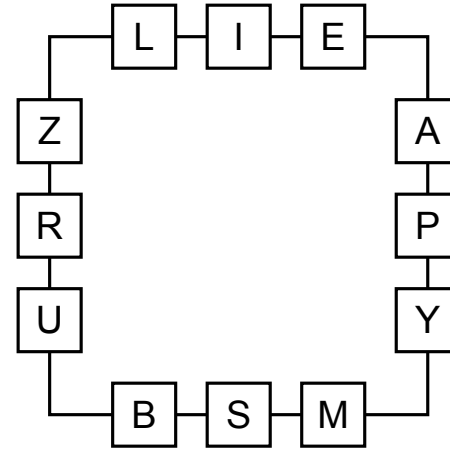

Letter Square Zine 2025-W38 / © SortedPuzzles

Letter Square Zine 2025-W38 / © SortedPuzzles

Puzzle 2

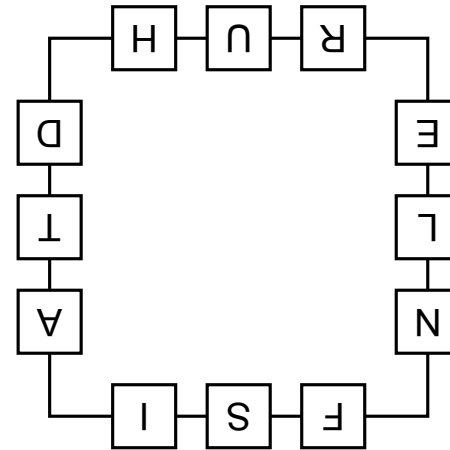

Letter Square Zine 2025-W38 / © SortedPuzzles

Puzzle 6

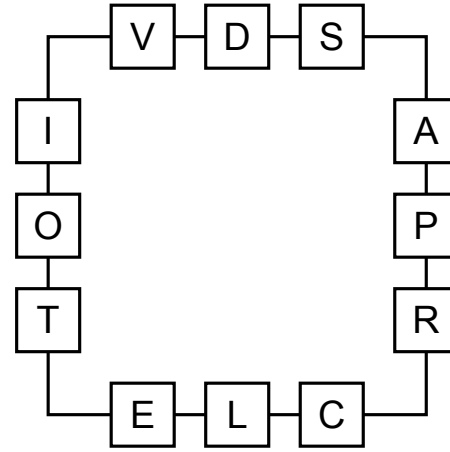

Letter Square Zine 2025-W38 / © SortedPuzzles

Letter Square Zine 2025-W38 / © SortedPuzzles

Puzzle 3

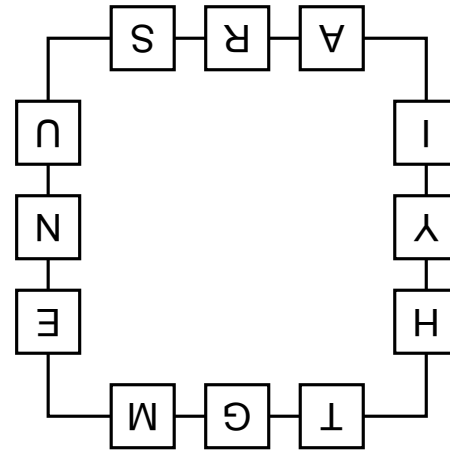

Letter Square Zine 2025-W38 / © SortedPuzzles

Puzzle 5

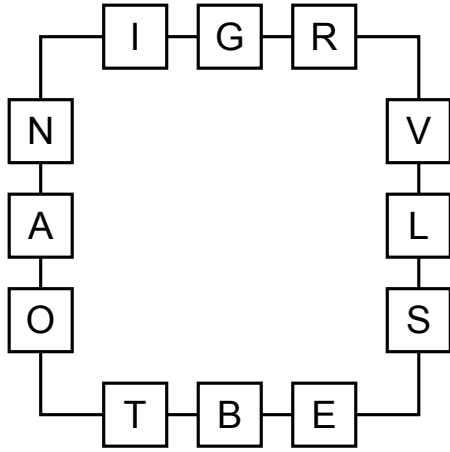

Letter Square Zine 2025-W38 / © SortedPuzzles

Letter Square Zine 2025-W38 / © SortedPuzzles

Puzzle 4

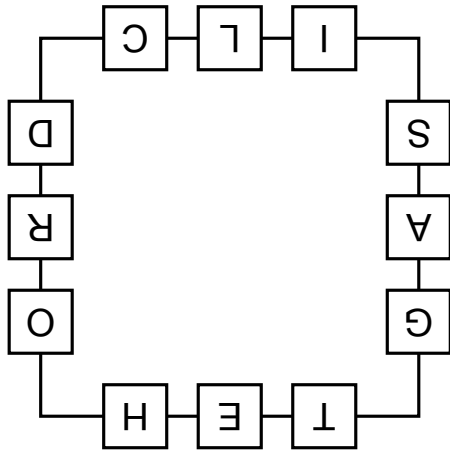

Letter Square Zine 2025-W38 / © SortedPuzzles

Puzzle 1

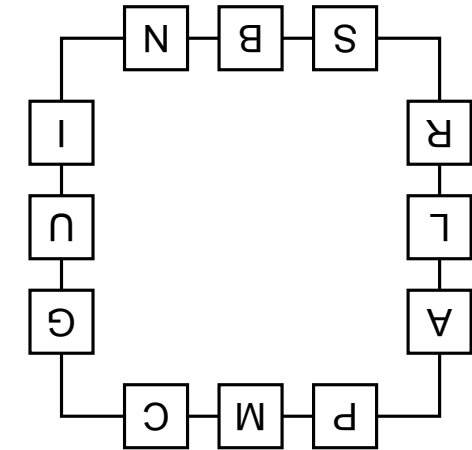

Letter Square Zine 2025-W38 / © SortedPuzzles