

ICHIMAGA

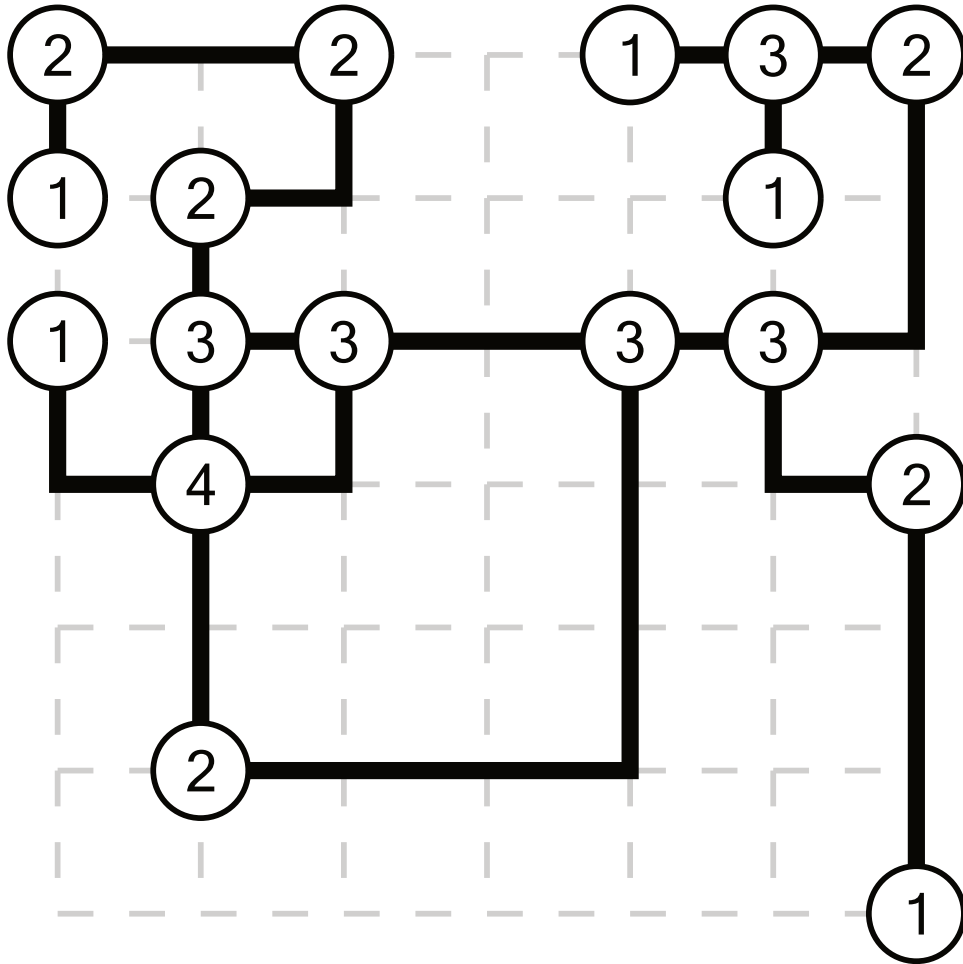

ICHI-2-007S; © SortedPuzzles