

MILK-TEASE

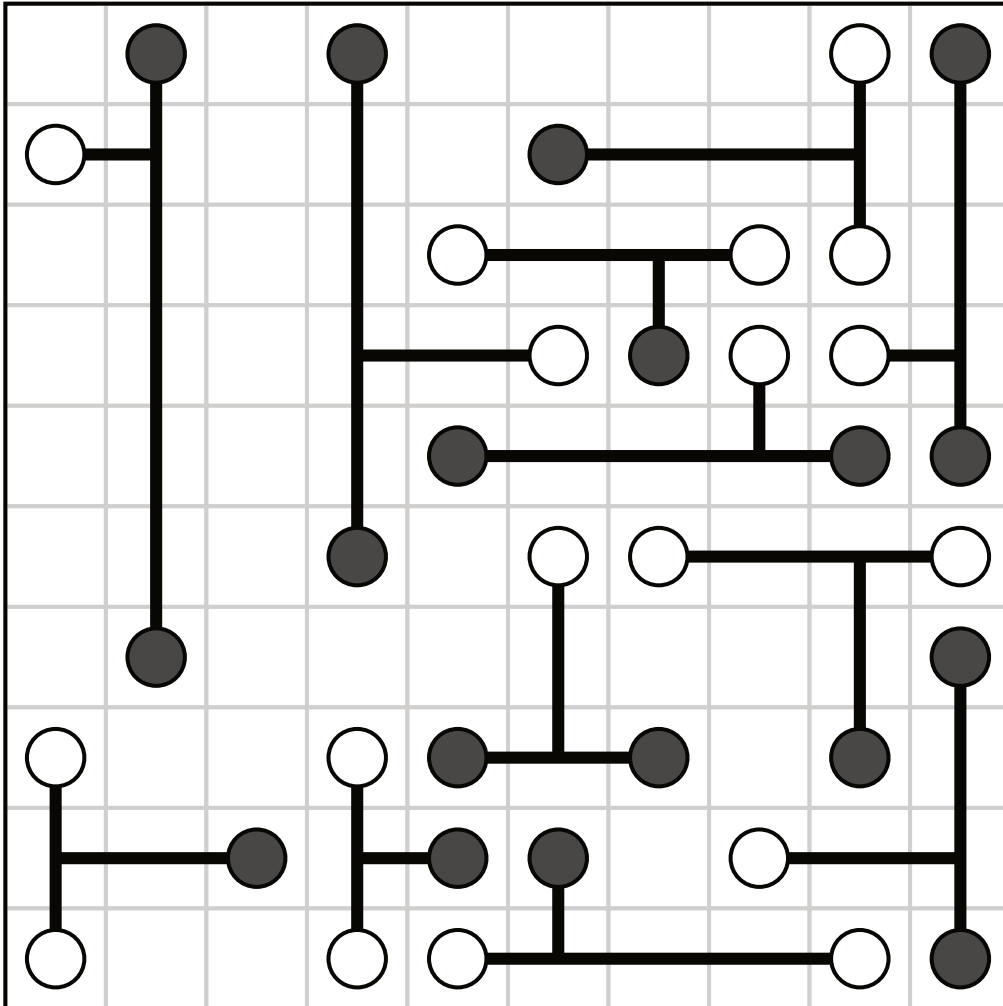

MTES-3-003S; © SortedPuzzles