

ICHIMAGA

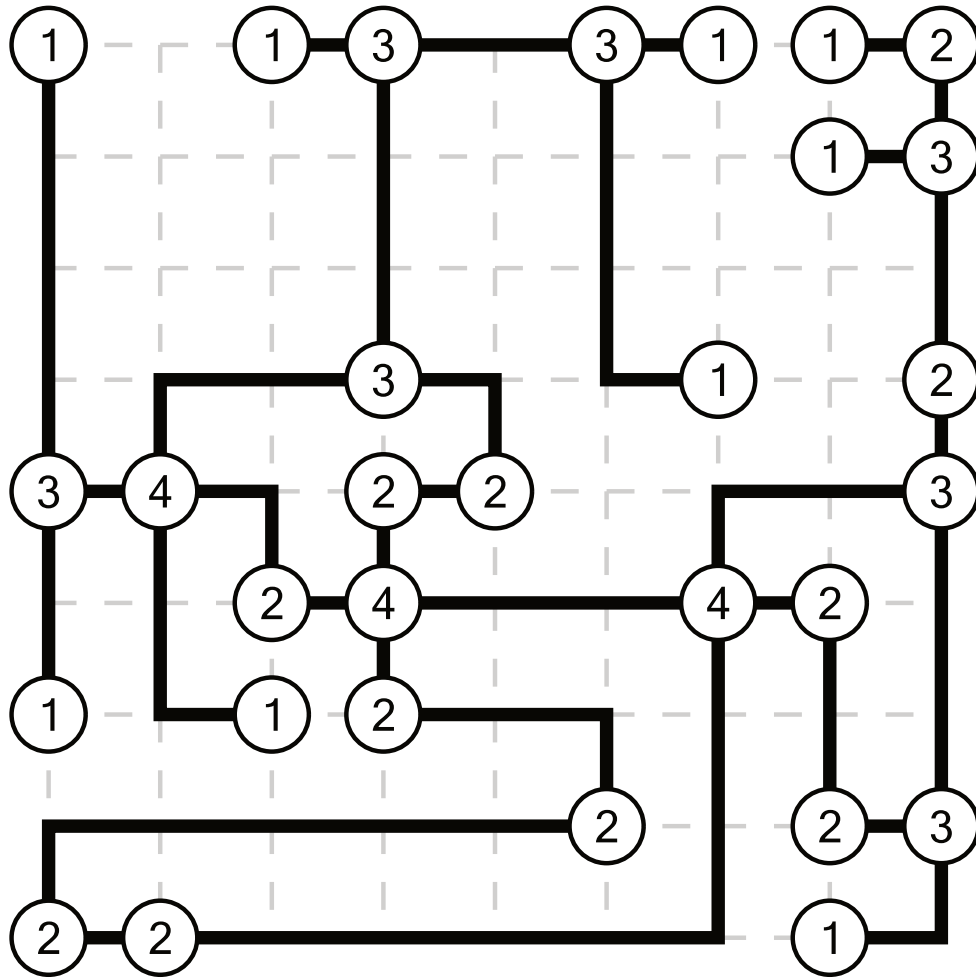

ICHI-4-004S; © SortedPuzzles