

HASHIWOKAKERO

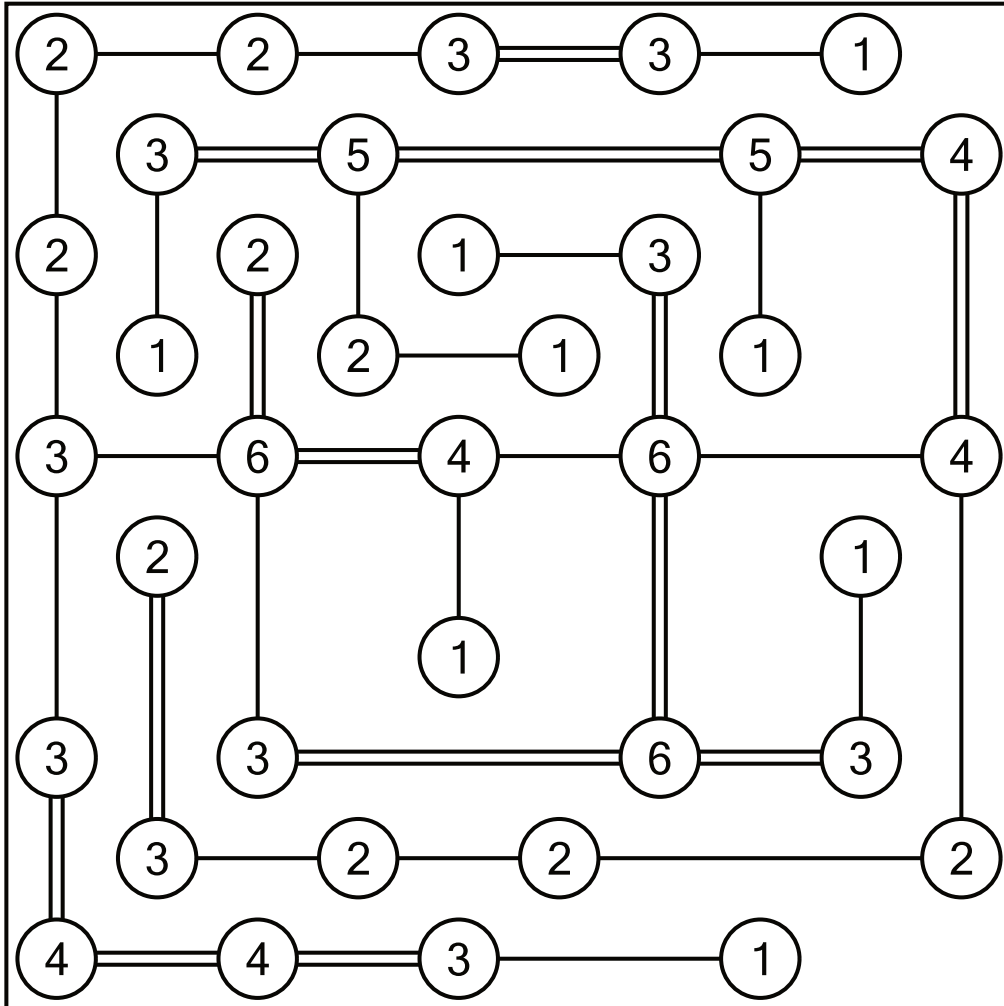

HASH-5-005S; © SortedPuzzles