

HASHIWOKAKERO

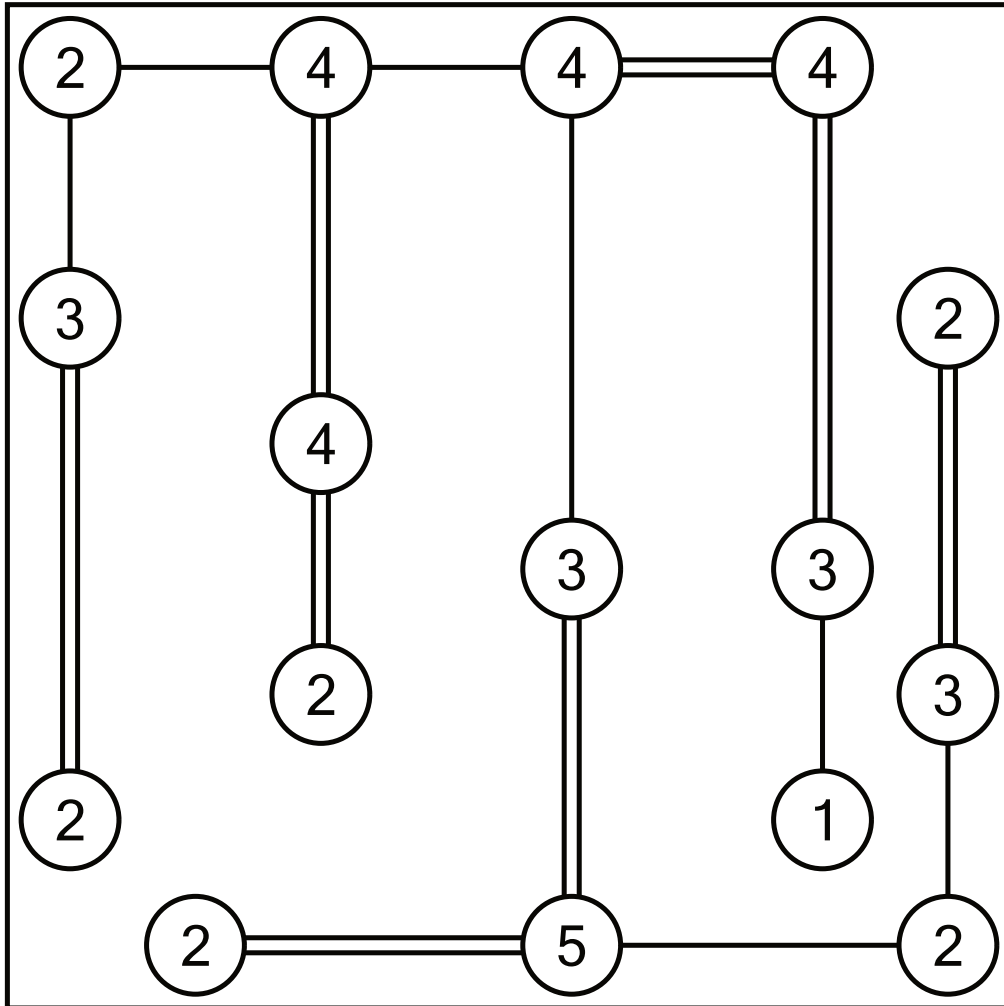

HASH-3-003S; © SortedPuzzles